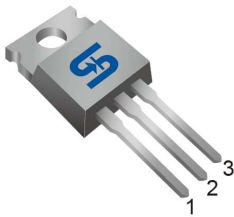
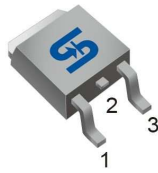


## 1A Low Dropout Positive Voltage Regulator

**TO-220**



**TO-252 (DPAK)**



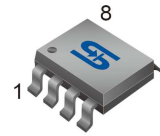
**SOT-223**



**Pin Definition:**

1. Fixed / Adj
2. Output (Tab)
3. Input

**SOP-8**



**Pin Definition:**

- |                |           |
|----------------|-----------|
| 1. Fixed / Adj | 8. N/C    |
| 2. Output      | 7. Output |
| 3. Output      | 6. Output |
| 4. Input       | 5. N/C    |

### General Description

TS1117 are high performance positive voltage regulators are designed for use in applications requiring low dropout performance at full rated current, Additionally, TS1117 provides excellent regulation over variations due to changes in line, load and temperature. Outstanding features include low dropout performance at rated current, fast transient response, internal current limiting and thermal shutdown protection of the output device. TS1117 are three terminal regulators with fixed and adjustable voltage options available in popular packages.

### Features

- Low Dropout Performance 1.5V max.
- Full Current Rating Over Line and Temperature
- Fast Transient Response
- ±2% Total Output Regulation Over Line, Load and Temperature
- Adjust Pin Current max 90uA Over Temperature
- Line Regulation Typical 0.015%
- Load Regulation Typical 0.05%
- Fixed / Adjustable Output Voltage

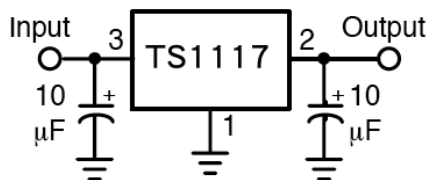
### Ordering Information

Part No.	Package	Packing
TS1117CZxx C0	TO-220	50pcs / Tube
TS1117CPxx RO	TO-252	2.5Kpcs / 13" Reel
TS1117CWxx RP	SOT-223	2.5Kpcs / 13" Reel
TS1117CSxx RL	SOP-8	2.5Kpcs / 13" Reel
TS1117CZxx C0G	TO-220	50pcs / Tube
TS1117CPxx ROG	TO-252	2.5Kpcs / 13" Reel
TS1117CWxx RPG	SOT-223	2.5Kpcs / 13" Reel
TS1117CSxx RLG	SOP-8	2.5Kpcs / 13" Reel

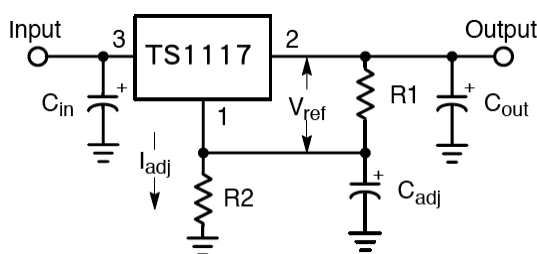
Note: Where **xx** denotes voltage option, available are 5.0V, 3.3V, 2.5V, 1.8V and 1.2V. Leave blank for adjustable version.

"G" denotes Halogen Free Products

### Typical Application Circuit



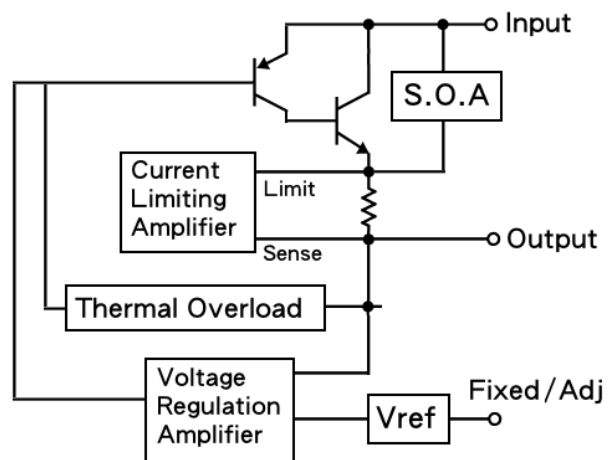
**Fixed Output Voltage Version**



$$V_{OUT} = V_{REF}(1+R2/R1) + I_{adj} R2$$

**Adjustable Output Voltage Version**

### Block Diagram



**Absolute Maximum Rating** (Note 1)

Parameter	Symbol	Limit	Unit
Input Supply Voltage	$V_{IN}$	12	V
Operation Input Supply Voltage	$V_{IN}$ (Opr. Typ.)	7	V
Power Dissipation (Note 2)	$P_D$	Internal limited	
Thermal Resistance Junction to Ambient	TO-220	80	°C/W
	TO-252	105	
	SOT-223	130	
	SOP-8	160	
Operating Junction Temperature Range	$T_J$	0 ~ +125	°C
Storage Temperature Range	$T_{STG}$	-65 ~ +150	°C
Lead Soldering Temperature (260°C)	TO-220	10	S
	TO-252 / SOT-223 / SOP-8	5	

**Electrical Specification** ( $T_a = 25^\circ\text{C}$ , unless otherwise specified.)

Parameter	Conditions	Min	Typ	Max	Unit
Reference Voltage	$V_{IN} = 5, I_o = 10\text{mA}$	1.237	1.25	1.262	V
	$V_{IN} = 2.75, I_o = 10\text{mA} \sim 1\text{A}$	1.225		1.275	
Output Voltage (Note 4)	$V_{IN} = 3.5\text{V}, I_o = 10\text{mA}$	1.485	1.5	1.515	V
	$V_{IN} = 3\text{V} \sim 7\text{V}, I_o = 10\text{mA} \sim 1\text{A}$	1.470		1.530	
	$V_{IN} = 3.8\text{V}, I_o = 10\text{mA}$	1.782	1.8	1.818	V
	$V_{IN} = 3.3\text{V} \sim 7\text{V}, I_o = 10\text{mA} \sim 1\text{A}$	1.764		1.836	
	$V_{IN} = 4.5\text{V}, I_o = 10\text{mA}$	2.475	2.5	2.525	V
	$V_{IN} = 4\text{V} \sim 7\text{V}, I_o = 1\text{A}$	2.450		2.550	
	$V_{IN} = 5.3\text{V}, I_o = 10\text{mA}$	3.267	3.3	3.333	V
	$V_{IN} = 4.8\text{V} \sim 7\text{V}, I_o = 1\text{A}$	3.235		3.366	
	$V_{IN} = 7\text{V}, I_o = 10\text{mA}$	4.950	5.0	5.050	V
	$V_{IN} = 6.5\text{V} \sim 7\text{V}, I_o = 1\text{A}$	4.900		5.100	
Line Regulation	$V_o + 1.5\text{V} \leq V_{IN} \leq 7\text{V}, I_o = 10\text{mA}$	--	0.015	0.2	%
Load Regulation (Note 1,2)	$V_{IN} = V_{OUT} + 1.5\text{V}, I_o = 10\text{mA} \sim 1\text{A}$	--	0.05	1.0	%
Dropout Voltage	$I_o = 1\text{A}, \Delta V_{OUT} = 1\% V_{OUT}$	--	1.3	1.5	V
Quiescent Current	$V_{IN} = 5\text{V}$	--	8	10	mA
Adjustable Pin Current		--	90	--	uA
Output Current Limit	$V_{IN} - V_{OUT} = 3\text{V}$	1.1	--	--	A
Temperature Stability	$I_o = 10\text{mA}$	--	0.5	--	%
Ripple Rejection	$F = 120\text{Hz}, I_o = 1\text{A}, C_{OUT} = 25\mu\text{F},$ $V_{IN} = V_{OUT} + 3\text{V}$	--	60	70	dB

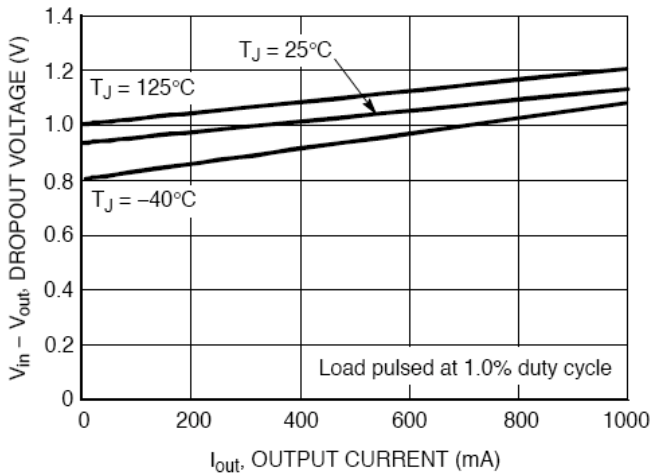
Note 1: See thermal regulation specification for changes in output voltage due to heating effects. Line and load regulation are measured at a constant junction temperature by low duty cycle pulse testing. Load regulation is measured at the output lead = 1/18" from the package.

Note 2: Line and load regulation are guaranteed up to the maximum power dissipation of 15W. Power dissipation is determined by the input / output voltage difference and the output current. Guaranteed maximum power dissipation will not be available over the full input / output voltage range.

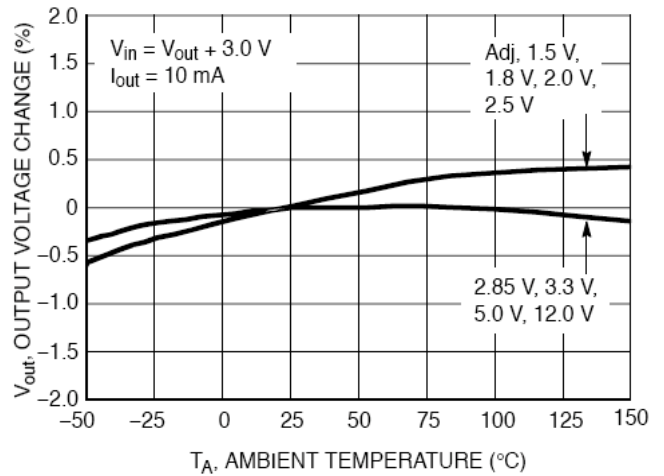
Note 3: Quiescent current is defined as the minimum output current required to maintain the regulation.

Note 4: The Output Capacitor does not have a theoretical upper limit and increasing its value will increase stability  $C_{OUT} = 100\mu\text{F}$  or more is typical for high current regulator design.

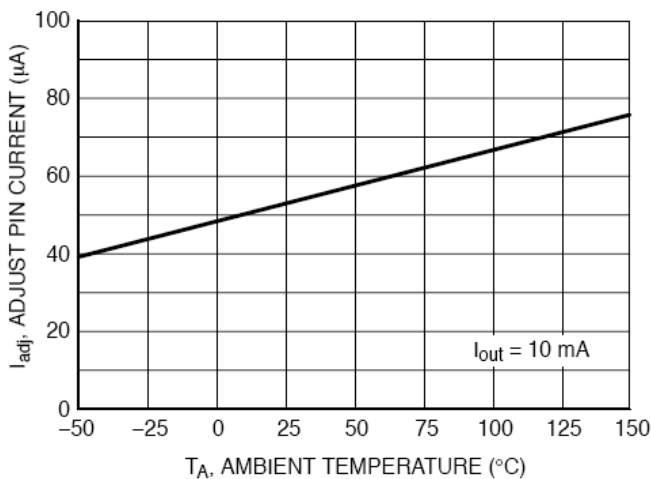
**Electrical Characteristics Curve**



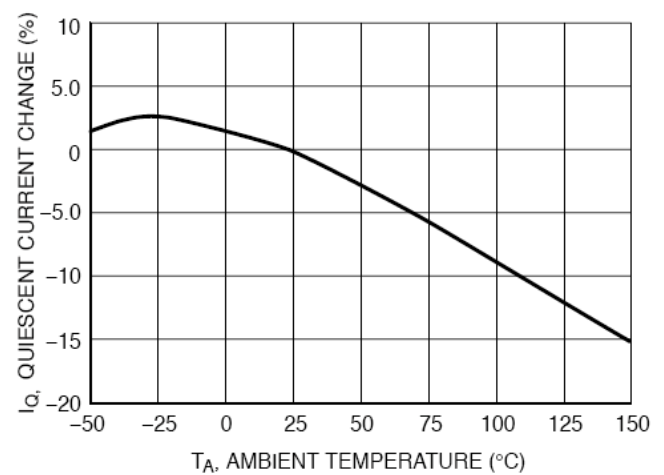
**Figure 1. Vdrop vs. Output Current**



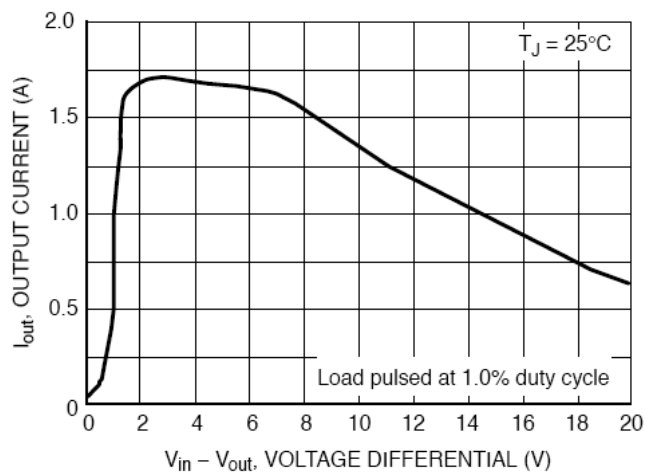
**Figure 2. Vout Change vs. Temperature**



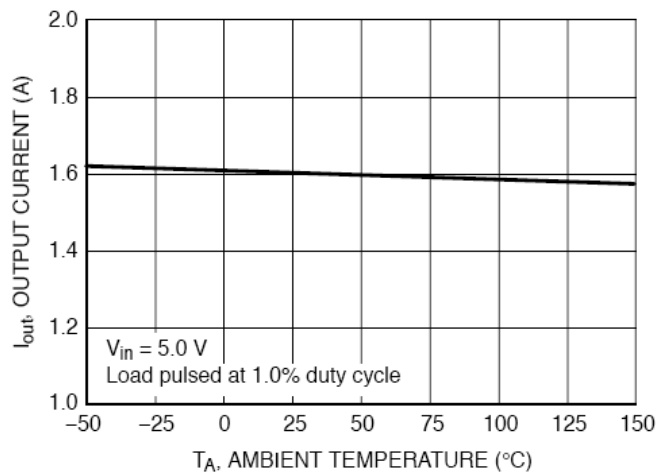
**Figure 3. Adjust Pin Current vs. Temperature**



**Figure 4. Iq Change vs. Temperature**

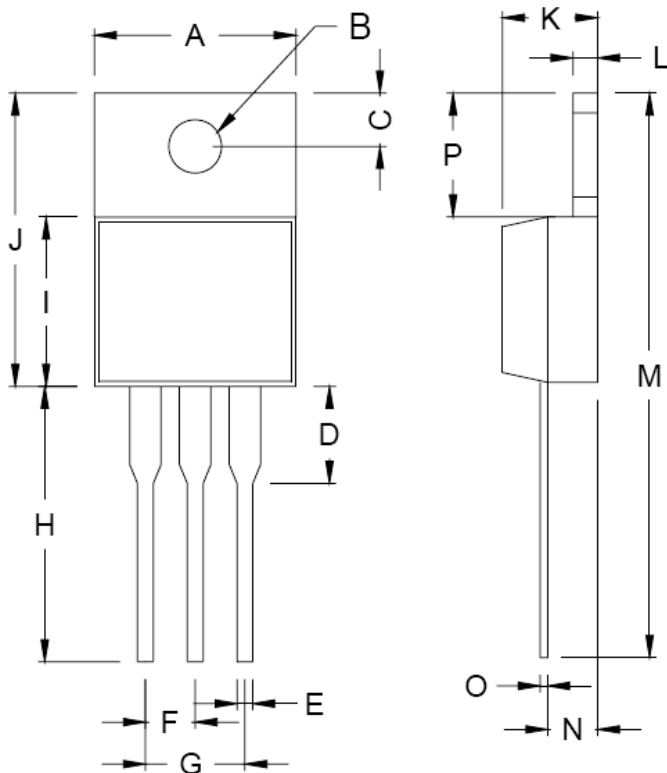


**Figure 5. Output Short Circuit Current vs. Differential Voltage**



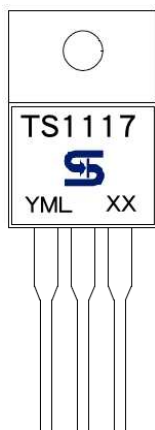
**Figure 6. Output Short Circuit Current vs. Temperature**

**TO-220 Mechanical Drawing**



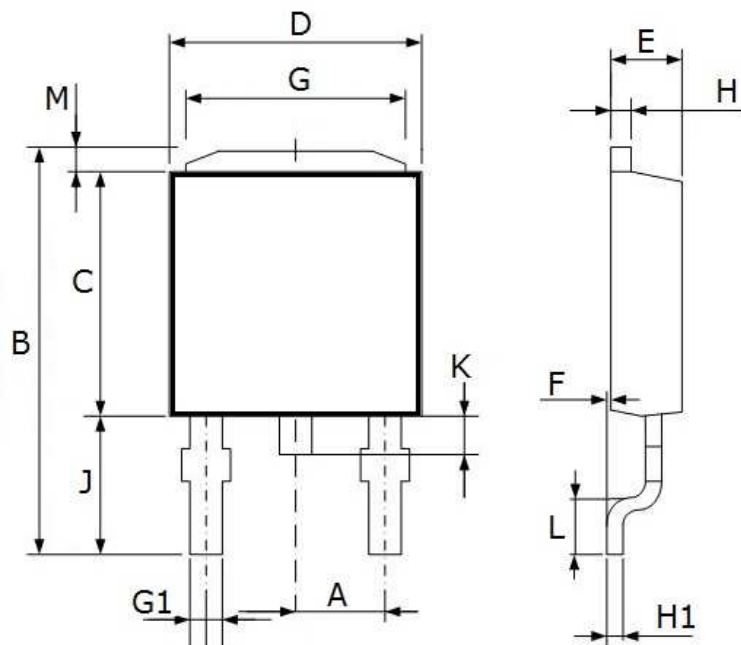
DIM	TO-220 DIMENSION			
	MILLIMETERS		INCHES	
	MIN	MAX	MIN	MAX
A	10.000	10.500	0.394	0.413
B	3.740	3.910	0.147	0.154
C	2.440	2.940	0.096	0.116
D	-	6.350	-	0.250
E	0.381	1.106	0.015	0.040
F	2.345	2.715	0.092	0.058
G	4.690	5.430	0.092	0.107
H	12.700	14.732	0.500	0.581
I	8.382	9.017	0.330	0.355
J	14.224	16.510	0.560	0.650
K	3.556	4.826	0.140	0.190
L	0.508	1.397	0.020	0.055
M	27.700	29.620	1.060	1.230
N	2.032	2.921	0.080	0.115
O	0.255	0.610	0.010	0.024
P	5.842	6.858	0.230	0.270

**Marking Diagram**



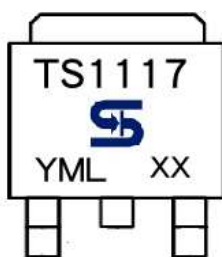
- Y** = Year Code
- M** = Month Code  
(**A**=Jan, **B**=Feb, **C**=Mar, **D**=Apr, **E**=May, **F**=Jun, **G**=Jul, **H**=Aug, **I**=Sep, **J**=Oct, **K**=Nov, **L**=Dec)
- = Month Code for Halogen Free Product  
(**O**=Jan, **P**=Feb, **Q**=Mar, **R**=Apr, **S**=May, **T**=Jun, **U**=Jul, **V**=Aug, **W**=Sep, **X**=Oct, **Y**=Nov, **Z**=Dec)
- L** = Lot Code
- XX** = Voltage Code  
(**1.5**=1.5V, **1.8**=1.8V, **2.5**=2.5V, **3.3**=3.3V, **5.0**=5V)  
= Package Code for Adjustable type  
(**CZ** = TO-220)

**TO-252 Mechanical Drawing**



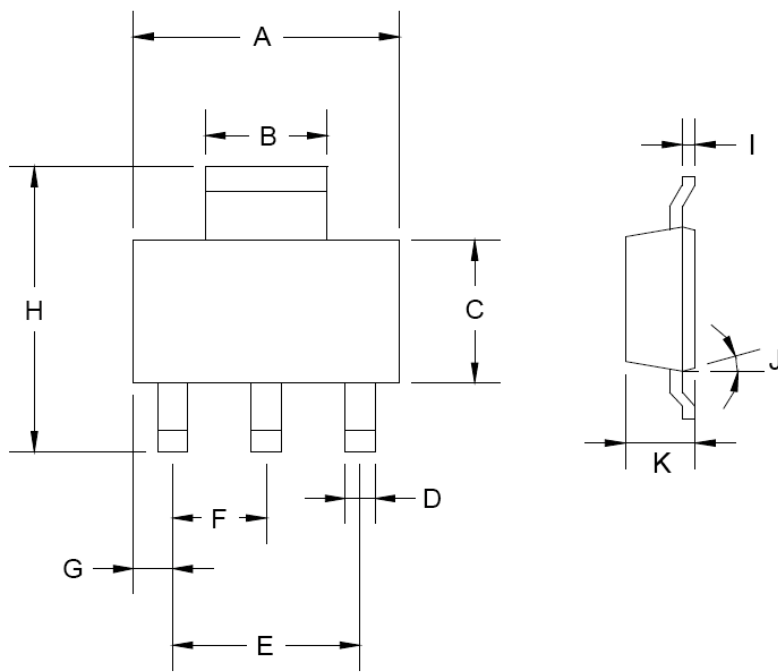
TO-252 DIMENSION				
DIM	MILLIMETERS		INCHES	
	MIN	MAX	MIN	MAX
A	2.30 BSC		0.090 BSC	
B	10.20	10.80	0.402	0.425
C	5.30	5.70	0.209	0.224
D	6.30	6.70	0.248	0.264
E	2.10	2.50	0.083	0.098
F	0.00	0.20	0.000	0.008
G	4.80	5.20	0.189	0.205
G1	0.40	0.80	0.016	0.031
H	0.40	0.60	0.016	0.024
H1	0.35	0.65	0.014	0.026
J	3.35	3.65	0.132	0.144
K	0.50	1.10	0.020	0.043
L	0.90	1.50	0.035	0.059
M	1.30	1.70	0.051	0.067

**Marking Diagram**



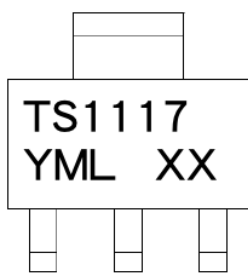
- Y** = Year Code
- M** = Month Code  
(A=Jan, B=Feb, C=Mar, D=Apr, E=May, F=Jun, G=Jul, H=Aug, I=Sep, J=Oct, K=Nov, L=Dec)
- = Month Code for Halogen Free Product  
(O=Jan, P=Feb, Q=Mar, R=Apr, S=May, T=Jun, U=Jul, V=Aug, W=Sep, X=Oct, Y=Nov, Z=Dec)
- L** = Lot Code
- XX** = Voltage Code  
(1.5=1.5V, 1.8=1.8V, 2.5=2.5V, 3.3=3.3V, 5.0=5V)
- = Package Code for Adjustable type  
(CP = TO-252)

**SOT-223 Mechanical Drawing**



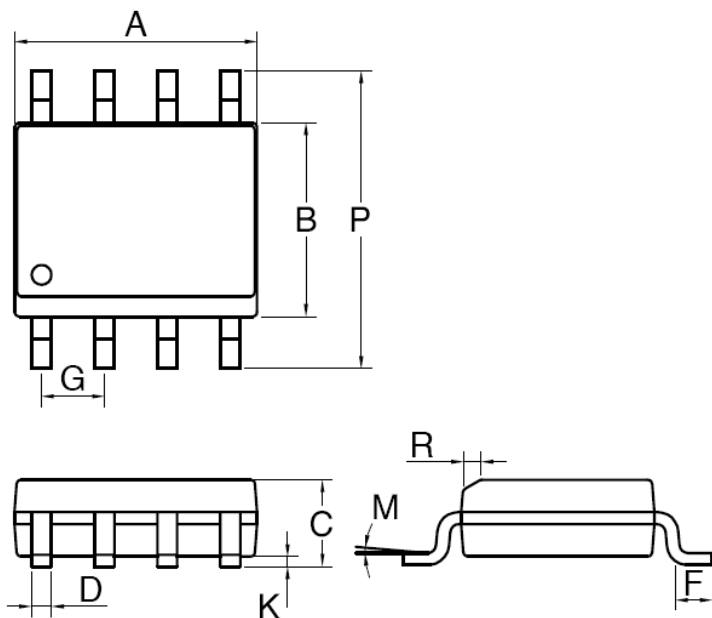
SOT-223 DIMENSION				
DIM	MILLIMETERS		INCHES	
	MIN	MAX	MIN	MAX
A	6.350	6.850	0.250	0.270
B	2.900	3.100	0.114	0.122
C	3.450	3.750	0.136	0.148
D	0.595	0.635	0.023	0.025
E	4.550	4.650	0.179	0.183
F	2.250	2.350	0.088	0.093
G	0.835	1.035	0.032	0.041
H	6.700	7.300	0.263	0.287
I	0.250	0.355	0.010	0.014
J	10°	16°	10°	16°
K	1.550	1.800	0.061	0.071

**Marking Diagram**



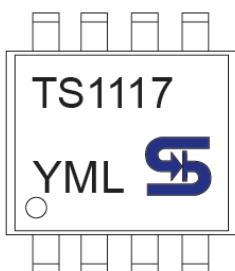
- Y** = Year Code
- M** = Month Code  
(**A**=Jan, **B**=Feb, **C**=Mar, **D**=Apr, **E**=May, **F**=Jun, **G**=Jul, **H**=Aug, **I**=Sep, **J**=Oct, **K**=Nov, **L**=Dec)
- = Month Code for Halogen Free Product  
(**O**=Jan, **P**=Feb, **Q**=Mar, **R**=Apr, **S**=May, **T**=Jun, **U**=Jul, **V**=Aug, **W**=Sep, **X**=Oct, **Y**=Nov, **Z**=Dec)
- L** = Lot Code
- XX** = Voltage Code  
(**1.5**=1.5V, **1.8**=1.8V, **2.5**=2.5V, **3.3**=3.3V, **5.0**=5V)
- = Package Code for Adjustable type  
(**CW** = SOT-223)

**SOP-8 Mechanical Drawing**



DIM	MILLIMETERS		INCHES	
	MIN	MAX	MIN	MAX.
A	4.80	5.00	0.189	0.196
B	3.80	4.00	0.150	0.157
C	1.35	1.75	0.054	0.068
D	0.35	0.49	0.014	0.019
F	0.40	1.25	0.016	0.049
G	1.27BSC		0.05BSC	
K	0.10	0.25	0.004	0.009
M	0°	7°	0°	7°
P	5.80	6.20	0.229	0.244
R	0.25	0.50	0.010	0.019

**Marking Diagram**



- Y** = Year Code
- M** = Month Code  
(A=Jan, B=Feb, C=Mar, D=Apl, E=May, F=Jun, G=Jul, H=Aug, I=Sep, J=Oct, K=Nov, L=Dec)
- = Month Code for Halogen Free Product  
(O=Jan, P=Feb, Q=Mar, R=Apl, S=May, T=Jun, U=Jul, V=Aug, W=Sep, X=Oct, Y=Nov, Z=Dec)
- L** = Lot Code
- XX** = Voltage Code  
(1.5=1.5V, 1.8=1.8V, 2.5=2.5V, 3.3=3.3V, 5.0=5V)
- = Package Code for Adjustable type  
(CW = SOT-223)

## Notice

Specifications of the products displayed herein are subject to change without notice. TSC or anyone on its behalf, assumes no responsibility or liability for any errors or inaccuracies.

Information contained herein is intended to provide a product description only. No license, express or implied, to any intellectual property rights is granted by this document. Except as provided in TSC's terms and conditions of sale for such products, TSC assumes no liability whatsoever, and disclaims any express or implied warranty, relating to sale and/or use of TSC products including liability or warranties relating to fitness for a particular purpose, merchantability, or infringement of any patent, copyright, or other intellectual property right.

The products shown herein are not designed for use in medical, life-saving, or life-sustaining applications. Customers using or selling these products for use in such applications do so at their own risk and agree to fully indemnify TSC for any damages resulting from such improper use or sale.